

OPERATION MAINTENANCE SERVICE MANUAL

DEXTER SWAY CONTROL (DSC)



DEXTER

www.dexteraxle.com

Introduction

Dexter is proud to put control and peace of mind in hauling a trailer or caravan back into your hands with the Dexter Sway Control System. This innovative device automatically stabilizes the sway of a trailer. It works independently of the tow vehicle and automatically applies the trailer or caravan brakes in the event of a sway.

As you are driving, the Dexter Sway Control System is constantly monitoring trailer yaw, or side-to-side movement, quickly recognizing and adjusting for sway conditions.

This manual is designed to provide information for you to understand, use, and guide you through the process of installing, operating, and maintaining your Dexter Sway Control System.

Assembled in the USA by Tuson RV Brakes, LLC.

Visit us online at www.dexteraxle.com



Dexter Sway Control (DSC) Trailer Mounting	3
DSC Mounting Location	3
Mounting Hardware	4
DSC Wiring	7
Trailer Battery	7
Ground Connections	8
12 Volt Connections	9
Electric Brake (Blue) Wire Connections	10
Left and Right Brake Wires	11
Wire Connections to Trailer Plug and System Overview ...	12
DSC Wiring Harness	13
Functional Test Procedure	15
Testing the DSC for Correct Wiring	15
The DSC Status Light Module	18
Status Light and Troubleshooting	19
How the DSC Works	21
Limited Warranty	22
Video Gallery	25

Table of Contents



Scan to view
Sway Control video

⚠ CAUTION

This is the safety alert symbol. It is used to alert you to potential injury hazards. Obey all safety messages that follow this symbol to avoid possible injury or death.

CAUTION

The Dexter Sway Control should only be installed by a qualified technician.

DSC Trailer Mounting

DSC Mounting Location

Select a location on the trailer to mount the DSC. The location must be 5 to 10 feet behind the trailer bumper hitch ball and shielded from road debris. The DSC must be securely fastened onto a vertical surface that does not flex or move from wind, such as plastic covers or plastic walls. The center of the DSC (marked by a red dot on the DSC label shown below) must be positioned on the “center line” of the trailer and the DSC must be mounted with the correct side in the UP direction as indicated on the label. The longest edge of the DSC (as indicated by a red line on the label) must be mounted parallel to the trailer axle beam(s). See Figure 1.

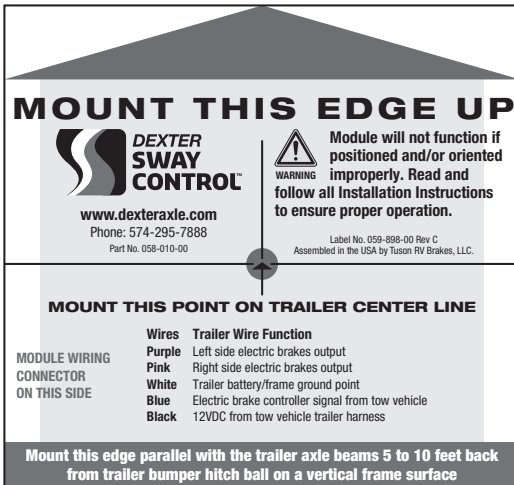



It is essential that the DSC be oriented in the proper direction when it is installed.

CAUTION

Ensure the electric brakes are adjusted and maintained in accordance with the manufacturer's recommendations in your owner's manual for proper operation of the sway control module.

Mounting Hardware

The DSC should be mounted using the mounting flanges which are located on both sides of the unit. Included are four (4) #10 self-tapping screws to mount the DSC to the trailer.

You must **NOT** drill holes in the DSC for any reason. Drilling holes or puncturing the unit VOIDS YOUR WARRANTY.

CAUTION

Do not spray high pressure water on the DSC. The DSC is a weather sealed water resistant unit, but it is not designed to withstand direct high pressure spray from a power washer.

Dexter Sway Control Mounting

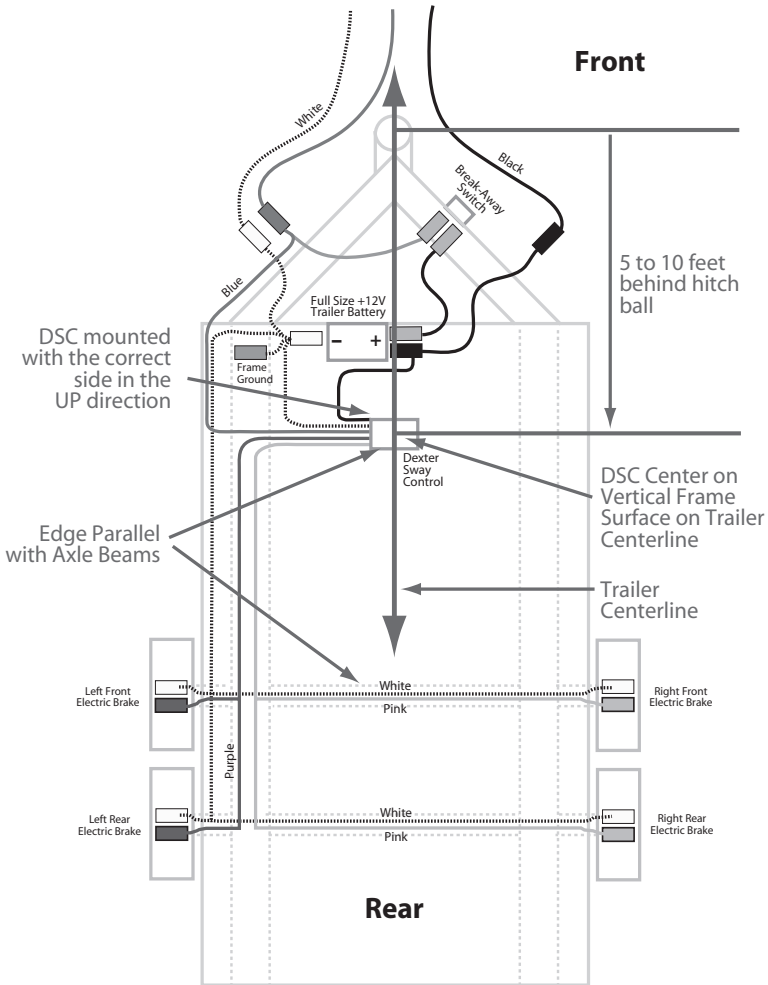

Figure 1

It is essential that the DSC be oriented in the proper direction when it is installed.





Dimensional Information for Locating and Mounting

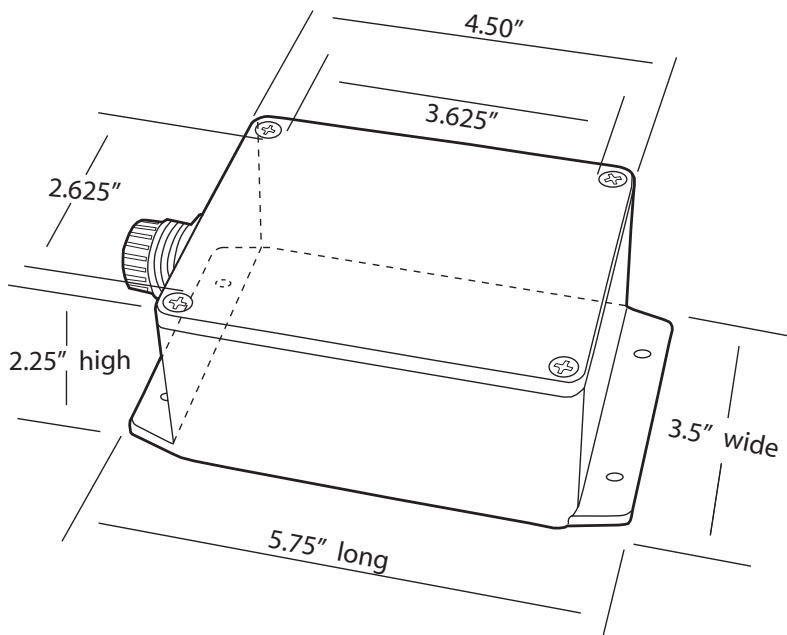

Figure 2

DSC Wiring

Trailer Battery

The trailer must be equipped with a full size 12 volt battery. **Small, gel-cell type batteries must not be used with the DSC.**

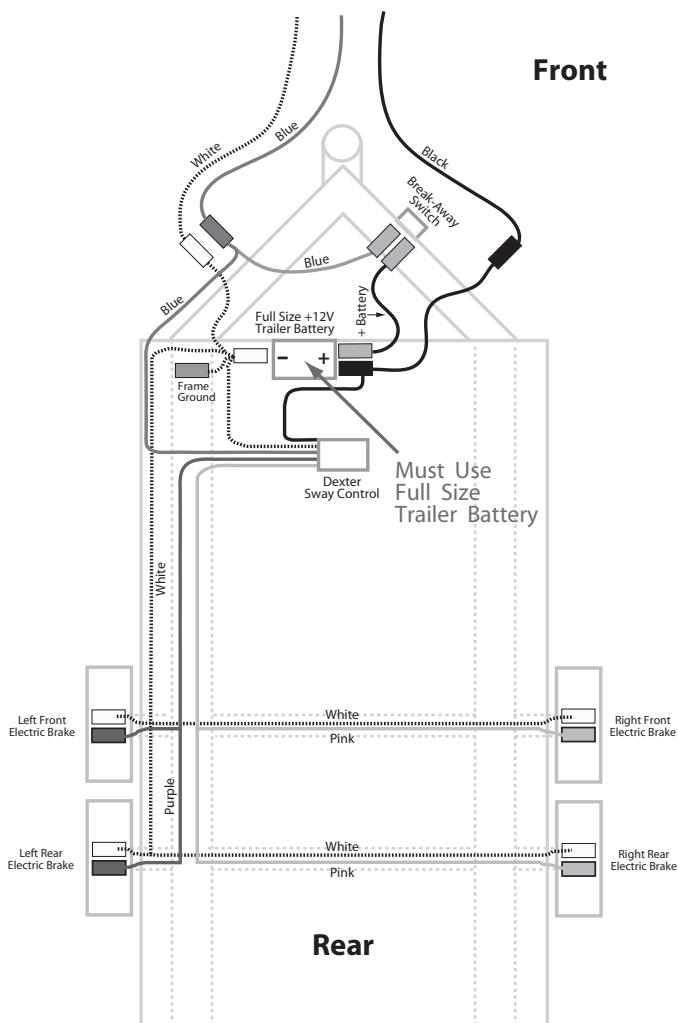

Figure 3





Ground Connections

The tow vehicle ground, trailer battery ground, trailer frame ground, DSC ground (white) wire and the electric brake ground wires on both sides of the trailer, must all be securely connected together with 14 gauge wire (min.) in order for the DSC to function properly.

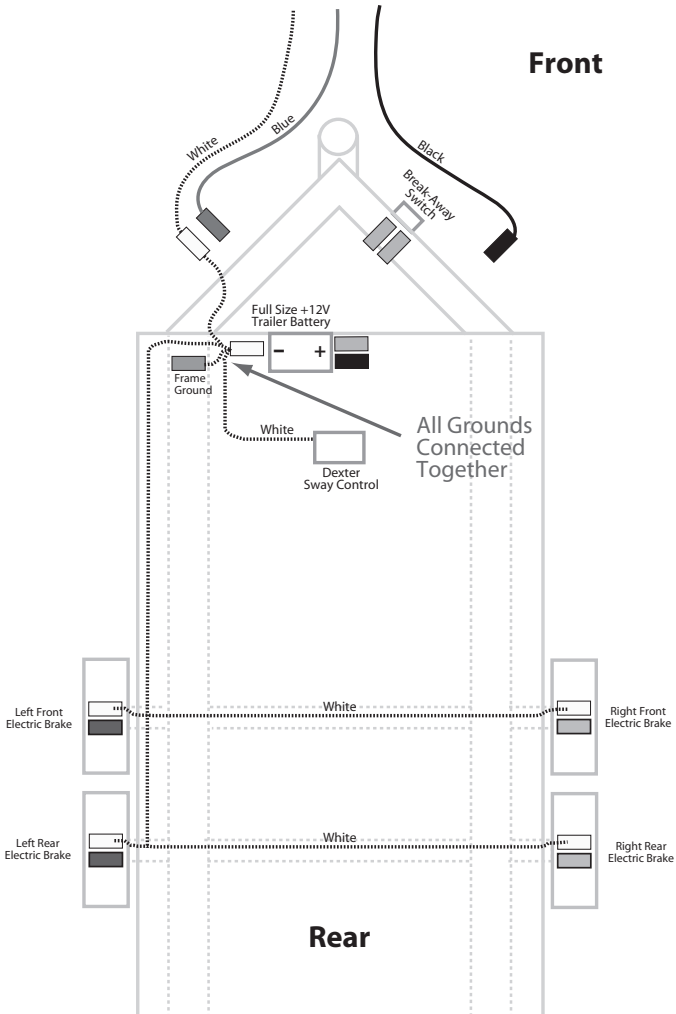

Figure 4

12 Volt Connections

The tow vehicle 12 volt charge line, the 12 volt trailer battery terminal and the DSC 12 volt (black) wire must be securely connected together with 14 gauge wire (min.) in order for the DSC to function properly. The “hot” wire from the breakaway switch must be connected to the +12V terminal of the trailer battery.

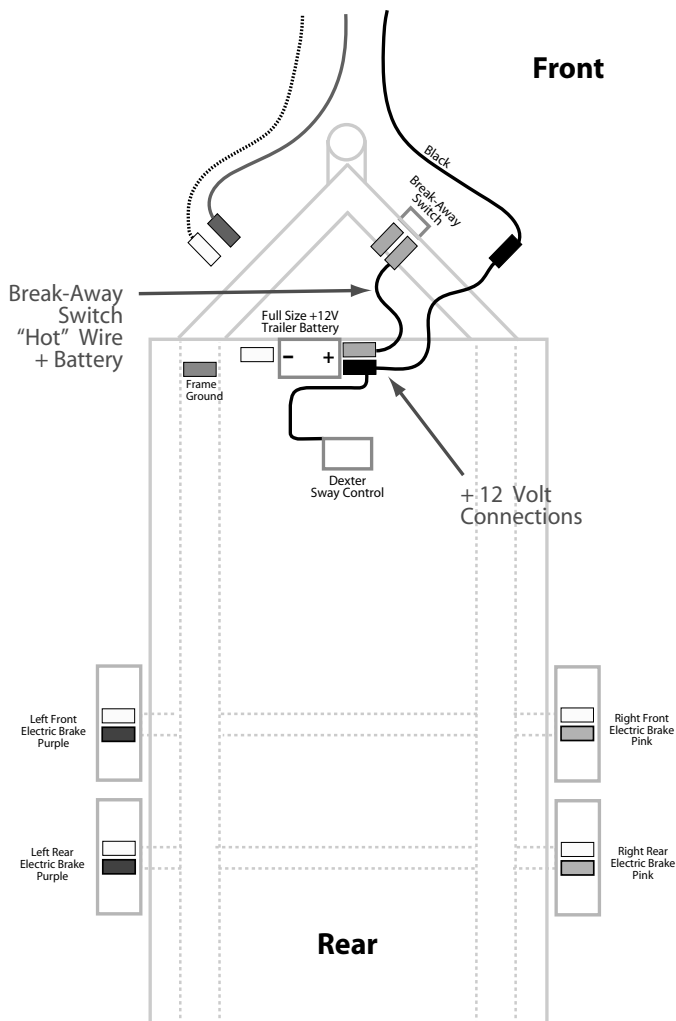

Figure 5





Electric Brake (Blue Wire) Connections

The tow vehicle brake controller signal (blue) wire must be securely connected to the DSC brake signal (blue) wire as well as to the “cold” wire from the breakaway switch as shown in the wiring diagram.

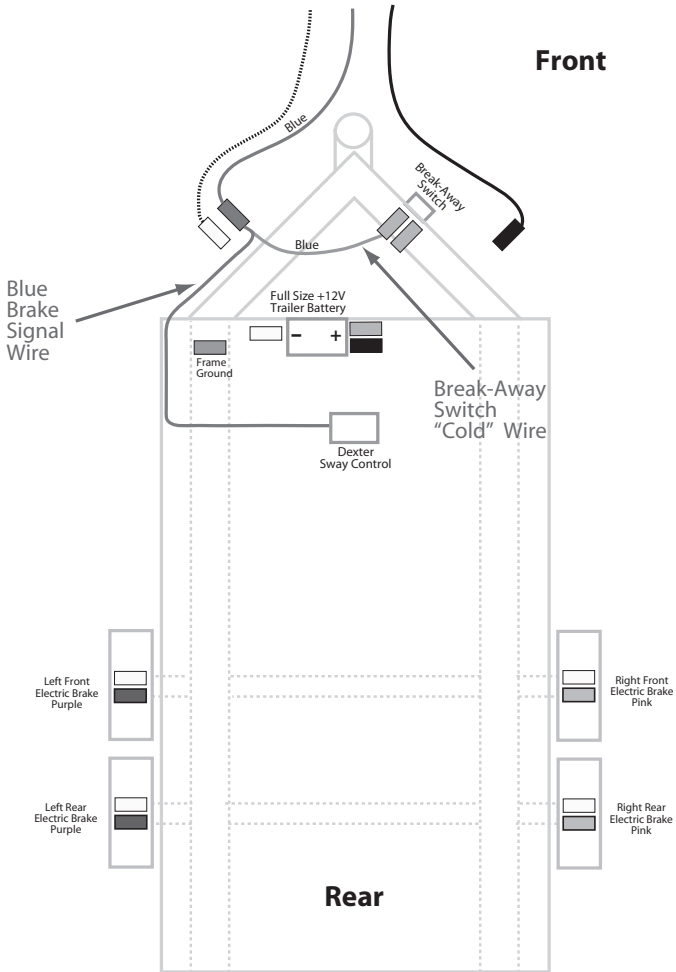

Figure 6

Left and Right Side Brake Wires

The DSC operates the left and right side trailer brakes independently in order to control trailer sway and therefore it is very important that the correct DSC wires are connected to the correct side brakes. The DSC purple wire must be connected to the left side electric brakes with a 14 gauge (min.) wire. The DSC pink wire must be connected to the right side electric brakes with a 14 gauge (min.) wire. Failure to properly connect these wires will prevent the DSC from controlling trailer sway.

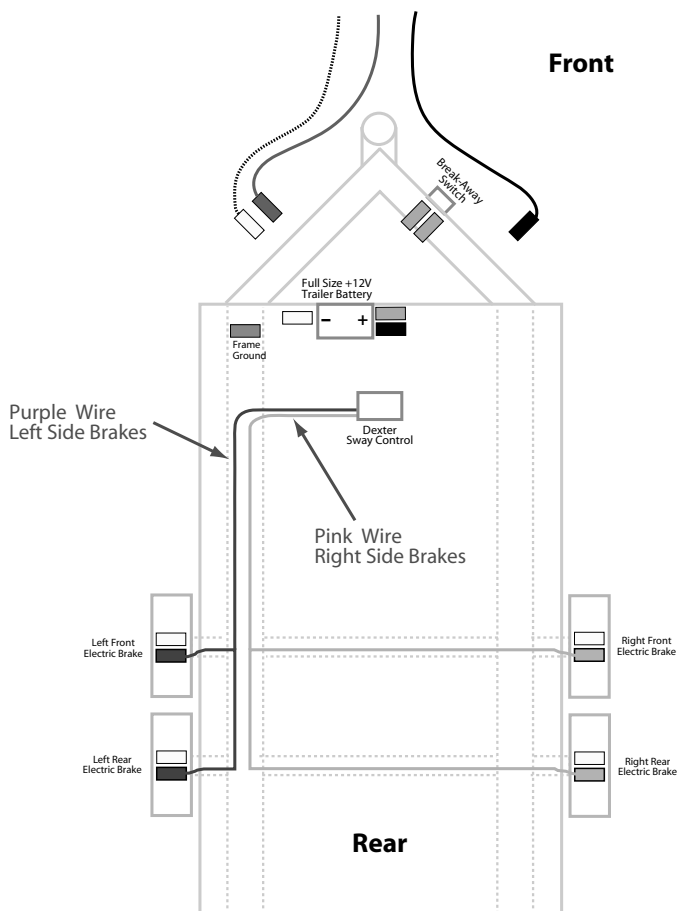
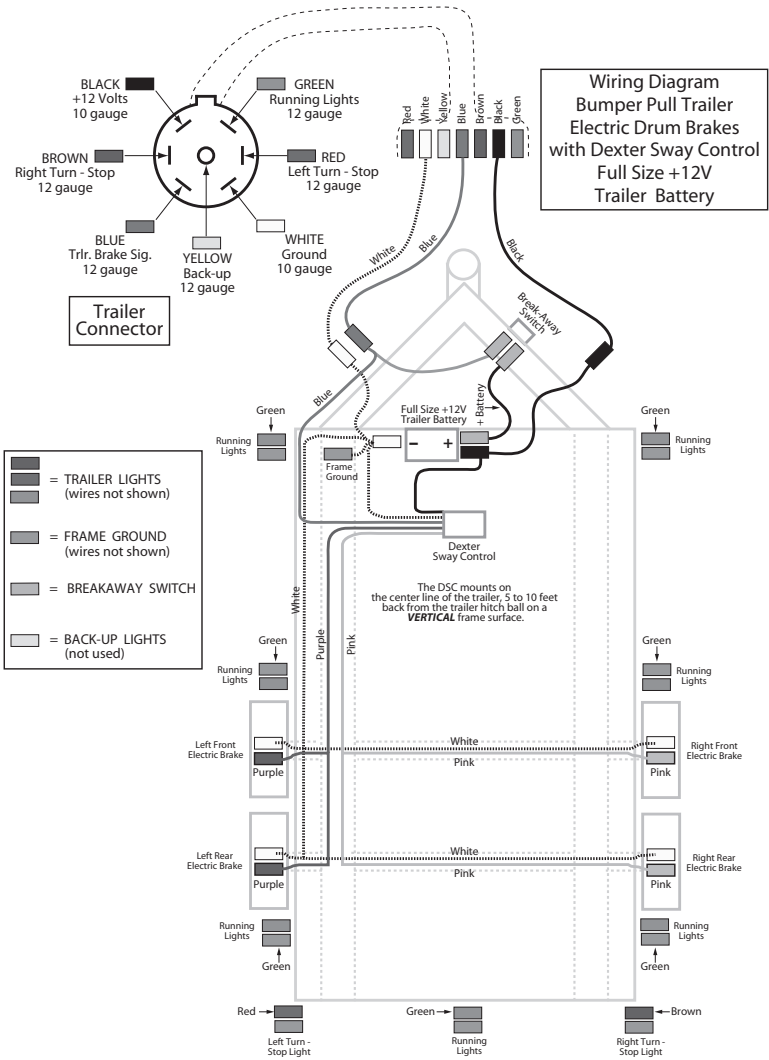

Figure 7





Wire Connections to Trailer Plug and System Overview



Dexter Sway Control Wiring

Figure 8

DSC Wiring Harness

The DSC wire harness has five wires requiring electrical connection and one wire for the status LED light. The function of each of these wires is outlined in the table below:

DSC Wires	Trailer Wire Function	Wire Gauge Required
Purple Wire	Left side electric brake output (all left side brakes)	14 Gage Minimum
Pink Wire	Right side electric brake output (all right side brakes)	14 Gage Minimum
White Wire	Trailer battery/frame ground point	14 Gage Minimum
Blue Wire	Electric brake controller signal from tow vehicle	14 Gage Minimum
Black Wire	12VDC from tow vehicle trailer harness	14 Gage Minimum
Gray Wire	10' wire with a two pin connector on the end that plugs into the LED status light	Included in kit

The 14 gauge wires of the DSC wiring harness are approximately 12" long to allow for flexibility when mounting the unit. Extensions will be required to connect unit to the trailer's electrical wiring. When making connections to the trailer's wiring harness, the desired termination is a solder joint. If the connection is not soldered, use the appropriate size and type of "crimp-type" weather sealed heat-shrink connectors, using the manufacturer's recommended crimping tools in accordance with their crimping instructions.

Once the 14 gauge wires are connected, route the Status Light wire to a location on the front of the trailer and mount the Status Light Module onto a flat surface using two (2) #6 self-tapping screws. Select a location that makes it easy to see the Status Light when looking at the front of the trailer.





Taking shortcuts when connecting any wires on your trailer only increases the likelihood that some part of your electrical system will fail. Make sure your splice connections are durable and sealed against exposure to water and corrosive elements. One loose wire connection can disable your entire trailer brake system.

When adding extension wires to the DSC wiring harness, you must use the correct gauge wire. These gauge sizes are outlined in the table above.

 CAUTION

Failure to use the correct gauge wire may result in poor braking performance or brake failure. Improper wire gauge may also result in significant damage to your trailer or its components, cause a fire, which may result in serious or fatal injury and/or property damage. Undersized wire will prevent electrical circuit protection devices such as fuses or circuit breakers from functioning properly. Undersized wire may melt or burn before these safety devices can be activated.

Functional Test Procedure

Testing the DSC for Correct Wiring

CAUTION

Before proceeding with the following test procedure, it is important to have the DSC unit powered on with a green status light. Failure to power the DSC before proceeding may result in a permanent failure or malfunction of the unit.

In order to verify that the DSC is wired correctly, follow the test process listed below:

1. Ensure that the trailer battery is fully charged or that a charging device is connected to the trailer.
2. Connect the +12V to the black wire on the DSC and ground the white wire from the DSC.
3. Connect a brake controller to the brake signal (blue) wire of the trailer harness.
4. Turn on the brake controller and apply the manual override until the DSC status light comes on.
5. Verify that the light is GREEN and that it is “flickering”. This indicates no faults with the DSC. If the light is not GREEN, refer to the troubleshooting section to correct the detected fault(s).
6. Refer to Figure 1 and Figure 2 on the following page to verify correct wiring on the left and right sides of the trailer. After the trailer passes the left side test, reconnect the left side brake as normal before repeating for the right side test.

Note: It is very important for the wire test connection to be made back near the left and right side trailer brakes. Do not perform this test up front near the DSC since that will not verify correct wiring back at the brakes.

7. If the DSC status light does not flash the correct number of times as indicated in Figures 1 and 2, make the necessary wiring changes so that the flashes match the correct side.





Functional Test Procedure

8. After the trailer passes the test as shown in Figures 1 and 2 and the brakes are reconnected as normal, verify that the GREEN flickering light is displayed. If it is not, refer to the troubleshooting section to correct the detected fault(s).

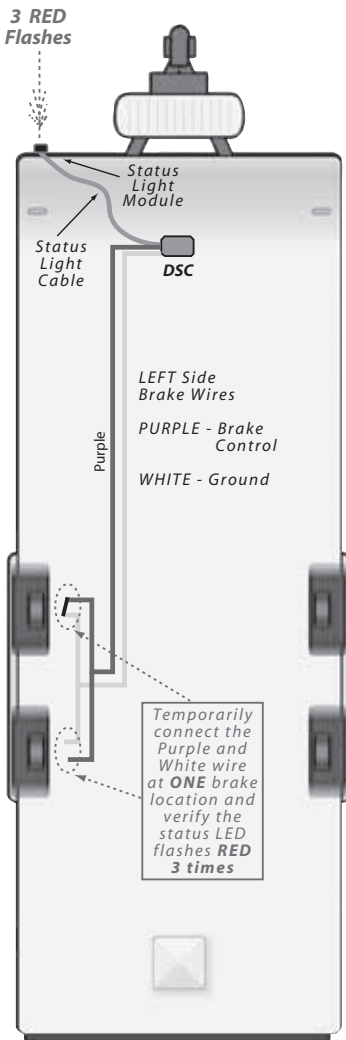

Figure 1

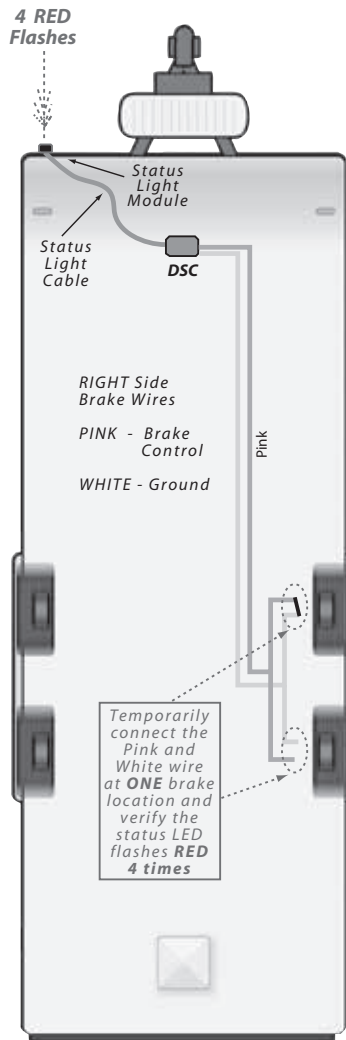

Figure 2





The DSC Status Light Module

The DSC performs a self-diagnostic test every time it “wakes up” by receiving a signal from a brake controller in the tow vehicle. The light will flash RED and GREEN approximately six times on startup and then go to GREEN. The DSC also continually monitors system parameters during operation. If the system is operating properly and no faults are detected, the GREEN light will remain ON and flicker or pulse. If a problem is detected, a RED light will flash a specific number of times to indicate the specific problem. The following Status Light and Troubleshooting table contains the meaning of the different RED and GREEN light flashes along with troubleshooting suggestions to correct the problem(s).

The DSC continues checking the fault status and keeps the RED light flashing until the fault is corrected. Once corrected, the GREEN light returns. Note that when the trailer is not moving, every 60 seconds the GREEN light will turn off for three seconds and back on. This is normal and indicates proper operation of the DSC. If the GREEN light is not turning off and on every 60 seconds while the trailer is not moving, have the DSC checked by your local service center.

Status Light and Troubleshooting

Mount the Status Light Module in a location on the front of the trailer where the light is easily seen.

Light Action	Condition	Corrective Action
Solid GREEN pulsing	Normal operation – no system faults	No action – system ok.
1 GREEN flash	Module reset to manufacturers default values. Keep trailer sitting still for minimum 30 seconds, then drive normally.	If module does not return to normal solid GREEN pulsing light after three system restarts, have the unit checked at a service center.
RED, GREEN. RED, GREEN, continuing...	Rough terrain mode.	No action – system will momentarily return to normal function.
No light	Unit in “sleep” mode.	Activate manual override on the brake controller to “wake up” unit.
No light	No power after “wake up” from brake controller.	Verify the unit has good quality power, ground and brake controller wire connections. Check for any blown fuses on the truck and trailer.
No light	Over voltage – over +20 volts.	Check that power source is not exceeding 20 volts. Correct voltage to 12-15 volts.





Status Light and Troubleshooting

Light Action	Condition	Corrective Action
No light	Low voltage – under 3 volts	Check that power source is 12-15 volts. Verify good power and ground connections
4 RED flashes	Brake short (right side)	Correct the short in right side brake wiring
3 RED flashes	Brake short (left side)	Correct the short in left side brake wiring
2 RED flashes	Sensor malfunction – no sway control	Service center repair required
1 RED flash	System malfunction	Service center repair required
Fast RED flashing	Low voltage – between 3 to 6 volts	Check the power and ground connections



How the Dexter Sway Control Works

1. The DSC continuously monitors trailer yaw.
2. It has a proprietary algorithm which is used to determine the difference between quick steering to avoid a road obstacle (or other such circumstances) and the rapid onset of a trailer swaying event.
3. It measures the angle, travel distance and speed of the lateral motion of the trailer (and other parameters) and uses this information to quickly intervene with the application of trailer brakes.
4. The processing capability of the DSC is powerful and rapid. It captures all the critical elements of the swaying condition and uses this information to predict how the event will proceed without any driver intervention.
5. It uses this data to get ahead of the event by applying the brakes on the correct side of the trailer, in a timely manner, with the proper braking level for the required duration.
6. This quickly damps and brings the trailer sway under control.
7. The DSC is based on the same technology used in automotive vehicle stability systems.

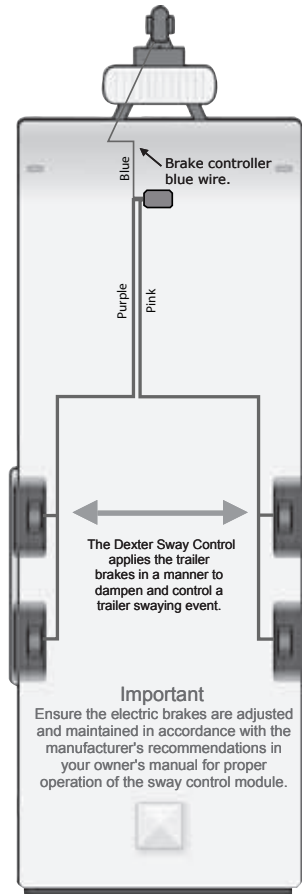

How the Dexter Sway Control Works





Dexter Axle Limited Warranty

What Products Are Covered

All Dexter Axle Company (“Dexter”) trailer axles, suspensions, and brake control systems manufactured on or after September 1, 2016, excluding Dexter 6000 series Manufactured Housing Axles. Additional exclusions include the following brands: UFP by Dexter, AL-KO (IAC), Titan Brakes and Actuators by Dexter, and BrakeRite by Dexter products, which are covered under separate warranties.

Limited 1 Year Warranty

As specified in Dexter’s current publication “Operation Maintenance Service Manual”, grease and oil seals FOR ALL PRODUCTS have a one (1) year limited warranty to the original purchaser from the date of first sale of the trailer incorporating such components. **Except as to grease and oil seals, the following four other warranties are available.**

Limited 2 Year Warranty

Dexter warrants to the original purchaser that its electric/hydraulic brake actuators shall be free from defects in material and workmanship for a period of two (2) years from the date of first sale of the trailer incorporating such components.

Limited 5 Year Warranty

Dexter warrants to the original purchaser that its axles, suspension systems and Genuine Replacement Parts shall be free from defects in material and workmanship for a period of five (5) years. The warranty period shall begin from the date of the original purchase of the trailer and/or Genuine Replacement Parts.

Limited 7 Year Warranty

Dexter warrants to the original purchaser that its Predator Series® electric brake controllers shall be free from defects in material and workmanship for a period of seven (7) years from the date of purchase.

Limited 10 Year Warranty

Dexter warrants to the original purchaser that the suspension components of its Torflex® axles shall be free from defects in material and workmanship for a period of ten (10) years from the date of first sale of the trailer incorporating such suspension components.

Exclusive Remedy

Dexter will, at its option, repair or replace the affected components of any defective axle, repair or replace the entire defective

Limited Warranty

axle, or refund the lesser of the original purchase price and the then-current list price of the axle or components. In all cases, a reasonable time period must be allowed for warranty repairs to be completed. Allowance will only be made for installation costs specifically approved by Dexter.

What You Must Do

In order to make a claim under these warranties:

1. You must be the original purchaser of the trailer in which the sprung suspension axles or Torflex® axles or components were originally installed.
2. You must promptly notify Dexter after detection of any defect, but in any case within the applicable warranty period of such defect, and provide us with the axle or applicable component serial number and any substantiation of such defect which may include, but is not limited to, the return of part(s) that we may reasonable request.

The axles, suspensions and components must have been installed and maintained in accordance with good industry practice and any specific Dexter recommendations, including those specified in Dexter's current publication "Operation Maintenance Service Manual".

Exclusions

These warranties do not extend to and do not cover defects caused by:

1. The connecting of brake wiring to the trailer wiring or trailer wiring to the towing vehicle wiring.
2. The attachment of the running gear to the frame.
3. Parts not supplied by Dexter.
4. Any damage whatsoever caused by or related to any alteration of the axle including welding supplemental brackets to the axle.
5. Use of an axle on a unit other than the unit to which it was originally mounted.
6. Normal wear and tear.
7. Improper alignment.
8. Improper installation.
9. Unreasonable use (including failure to provide reasonable and necessary maintenance as specified in Dexter's current publication "Operation Maintenance Service Manual including required maintenance after "Prolonged Storage").





10. Improper torque values and torquing of wheel nuts. (The proper torquing procedure and torque values are contained in Dexter's current publication "Operation Maintenance Service Manual").
11. Cosmetic finish or corrosion.

Limitations

1. **In all cases, Dexter reserves the right to fully satisfy its obligations under the Limited Warranties by refunding the lesser of the original purchase price and the then-current list price of the defective axle (or, if the axle has been discontinued, of the most nearly comparable current product).**
2. Dexter reserves the right to furnish a substitute of replacement component or product in the event an axle or any component of the axle is discontinued or is otherwise unavailable.
3. These warranties are nontransferable.

General

THE FOREGOING WARRANTIES ARE EXCLUSIVE AND IN LIEU OF ALL OTHER WARRANTIES EXCEPT THAT OF TITLE, WHETHER WRITTEN, ORAL OR IMPLIED, IN FACT OR IN LAW (INCLUDING ANY WARRANTY AGAINST INFRINGEMENT OR OF MERCHANTABILITY OR FITNESS FOR A PARTICULAR PURPOSE).

These warranties give you specific legal rights, and you may also have other rights which vary from state to state.

DEXTER HEREBY EXCLUDES INCIDENTAL AND CONSEQUENTIAL DAMAGES, INCLUDING LOSS OF TIME, INCONVENIENCE, LOSS OF USE, TOWING FEES, TELEPHONE CALLS, COST OF MEALS OR LODGING, FOR ANY BREACH OF ANY EXPRESS OR IMPLIED WARRANTY.

Some states do not allow limitations on how long an implied warranty lasts, or the exclusion or limitation if incidental or consequential damages, so the above exclusion or limitation may not apply to you.

Inquiries regarding these warranties should be sent to:

Dexter Axle Company
P.O. Box 250
Elkhart, IN 46515

Note: Current publication "Operation Maintenance Service Manual" can be found at www.dexteraxle.com.

Dexter Video Gallery

In keeping with our continual commitment to industry safety and the development of innovative products, please feel free to view our ongoing video gallery at www.dexteraxle.com/resources/videos or scan the following QR codes. We are confident these videos will help educate and promote the Dexter product line that you, as our customer, are investing in.



Bearing Maintenance



E/H Actuator Installation



E-Z Flex[®] Suspension



E-Z Lube[®] System



Genuine Brakes



Genuine Replacement Parts



Leaf Spring Axles



Medium Duty Axles



Nev-R-Adjust[®] Brakes



Removable Spindle



Sway Control



Torflex[®] Suspension Axles



Dexter Online Parts Store

From magnets and seals to complete brake and hub kits, Dexter offers a complete line of genuine replacement parts for your trailer. Most products are available in-stock and ready to ship within 24 hours direct to you from the factory. With dedicated customer support, quick turnaround and a 30-day money back guarantee, the Dexter Online Parts Store helps keep your trailer going.

- Hub Components
- Brake Components
 - Suspension Components
 - Complete Hub Kits
 - Brake Assemblies & Kits
 - Brake Controller & Brake Actuators



**Ready for Immediate Shipment
Direct to Your Door**

Visit us online at www.dexteraxle.com

Notes

Genuine Dexter axles and components are available nationwide from our plant locations listed below or through our network of distributors. Check our web site for the distributor nearest you.

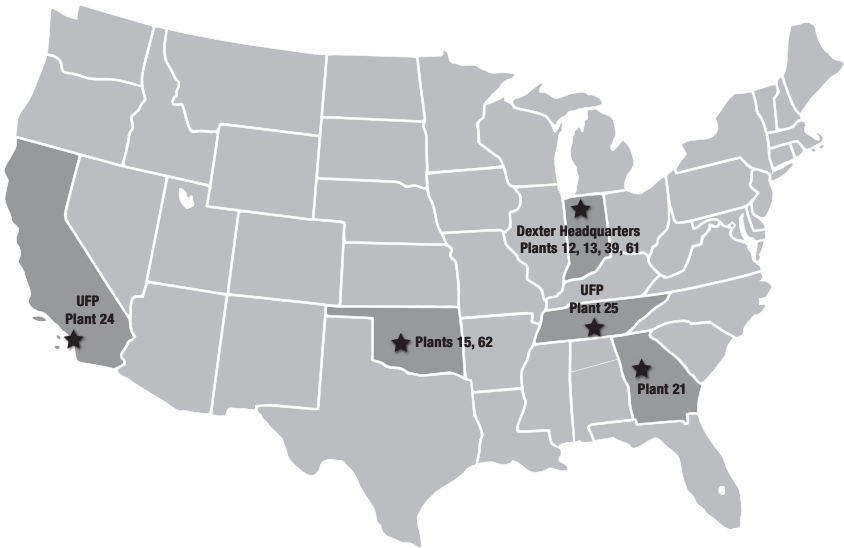

Dexter - Headquarters

2900 Industrial Parkway East ■ Elkhart, Indiana 46516
Phone: 574-295-7888 ■ Fax: 574-295-8666
www.dexteraxle.com

Dexter - Pit 12

301 West Pearl Street
Fremont, Indiana 46737
Phone: 260-495-5100
Fax: 260-495-1701

Dexter - Pit 13

500 South 7th Street
Albion, Indiana 46701
Phone: 260-636-2195
Fax: 260-636-3030

Dexter - Pit 15

500 Southeast 27th Street
El Reno, Oklahoma 73036
Phone: 405-262-6700
Fax: 405-262-9089

Dexter - Pit 21

199 Perimeter Road
Monticello, Georgia 31064
Phone: 706-468-6495
Fax: 706-468-2966

Ventline - Pit 39

902 South Division Street
Bristol, Indiana 46507
Phone: 574-848-4491
Fax: 574-848-4825
www.ventline.com

Dexter Door - Pit 39

902 South Division Street
Bristol, Indiana 46507
Phone: 574-848-4491
Fax: 574-848-4825
www.dexterdoor.com

Dexter - Pit 61

21611 Protecta Drive
Elkhart, Indiana 46516
Phone: 574-294-6651
Fax: 574-295-6626

Dexter - Pit 62

301 North Kennedy Street
Shawnee, Oklahoma 74801
Phone: 405-273-9315
Fax: 405-273-1054

UFP - Pit 24

135 Sunshine Lane
San Marcos, California 92069
Phone: 760-744-1610
Fax: 760-744-1616

UFP - Pit 25

1041 Baxter Lane
Winchester, Tennessee 37398
Phone: 931-967-5101
Fax: 931-967-1828

NO PART OF THIS CATALOG MAY BE REPRODUCED WITHOUT DEXTER'S PERMISSION.
ALL PART NUMBERS, DIMENSIONS AND SPECIFICATIONS IN THIS CATALOG ARE SUBJECT
TO CHANGE WITHOUT NOTICE.

GEARED FOR INNOVATION SINCE 1960



www.dexteraxle.com

2900 Industrial Parkway East ■ Elkhart, IN 46516

Phone: 574-295-7888 ■ Fax: 574-295-8666

ISO 9001 Certified

